

Specification

Basic series

BS3360



BS3360

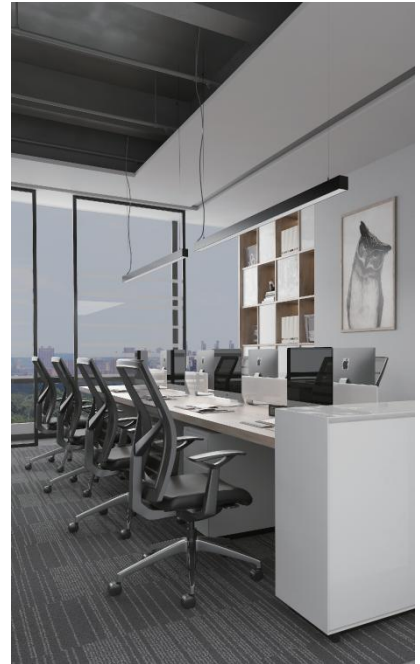

Features



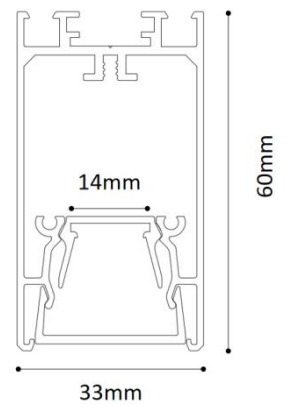

- Innovative buckle plug, no light leakage
- Carrier tight fit design carrier buckle extremely convenient for installation and maintenance
- Designed in anti-leaky block piece, perfect details
- Provide standard extenders, customizable interconnected corners
- Built-in linear power supply, invisible and beautiful
- Various installation ways: pendant, recessed, surface

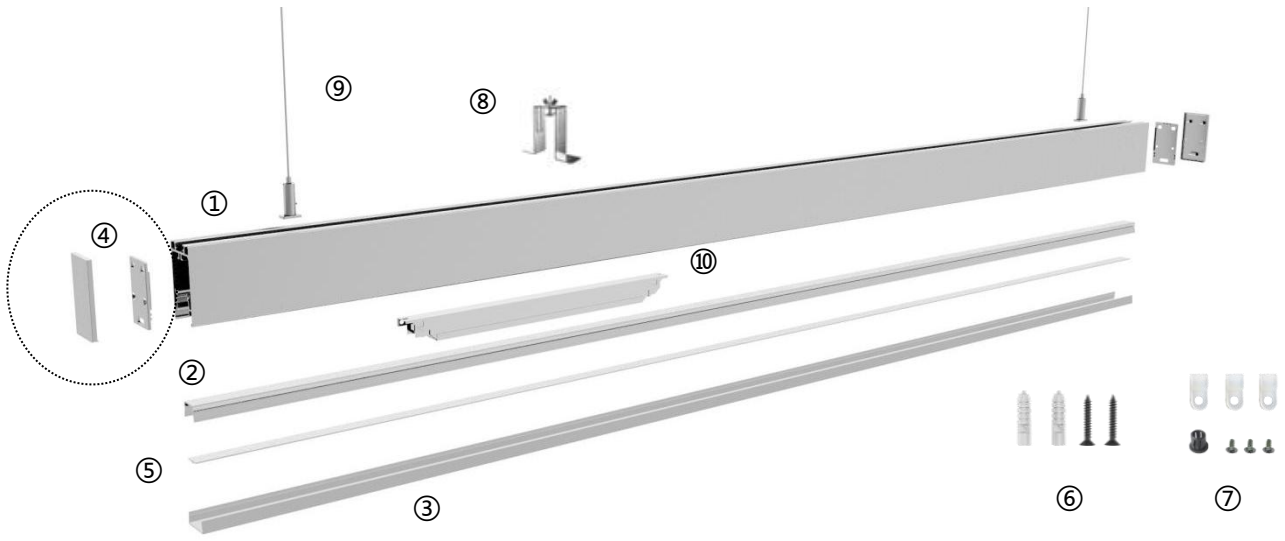









Details



Standard Configuration

Picture	Item	Parameter
	①Profile /②Carrier	Profile weight: 2.0825kg/2.5m Size: L2500*W33*H60mm Material: AL6063-T5 Surface processing: Anodizing
	③Cover	Type: Frosted diffuser Material: PC Light transmittance: 75% Size: L2500*W26.6*H10.2mm PC Feature: The diffuser will extend (shrink) 0.8mm/m when the temperature raises (drops) 10°C.
	④End cap	Model: EC-LS5470(F)FSS Size: L54*W70*H10.5mm
	⑥Install screw	Model: CL-01 Size: M3.5*40mm
	⑦Cable clip	Model: BG-01

Optional Accessories

Picture	Item	Parameter
	⑤Flexible strip DL8160-24V-8mm	Material: FPC,CCT:2700/3000/3500/4000/5000/6500K; CRI > 80/>90; Voltage: 24V; Power: 15W/m; Lumen: 2015Lm/m; Width: 8mm; Minimum cutting unit: 8LEDs/50mm;
	⑨Pendant cable with junction box	Model: PY-DXXX Junction box L80*W80*H30mm
	⑨Pendant cable without junction box	Model: PN-DXX Steel cable D1.5*2000/4000mm
	⑧Recessed buckle	Model: RE-01 Size: L110*W25*H82mm
	Reflective paper	Model: BG-22 Size: L15000*W10*H0.075mm
	Integrated track cabling accessories	Dimming: CM-03; CM-06 No dimming: CM-04; CM-05
	⑩Power supply	Model: BN-V24-060P-V1 Size: L261*W30*H17mm
	Whole lamp splice	Model: EX-38-S Size: L80*W51*H6mm

Corners

L-type corner (L90- BS3360)

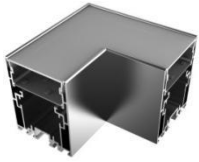

Al6063-T5
L150*W150*H60mm

L-type inner corner(L90N- BS3360)



Al6063-T5
L150*W150*H33mm

L-type exterior corner(L90W- BS3360)

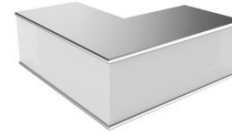

Al6063-T5
L150*W150*H33mm

T-type corner(T90- BS3360)



Al6063-T5
L300*W177*H60mm

X-type corner(X90- BS3360)



Al6063-T5
L300*W300*H60mm

* The corners can be provided with or without light source.

Optical Parameter

D8160-24V-8mm light source, frosted diffuser

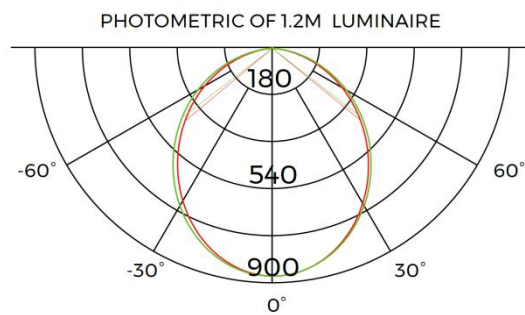

1m	312.8,877.3lx	243.14cm
2m	78.20,219.3lx	486.29cm
3m	34.75,97.48lx	729.43cm
5m	12.51,35.09lx	1215.71cm
7m	6.384,17.90lx	1966.01cm
Height	Eavg,Emax	Angle:101.12deg Diameter

Package

SEL Individual :

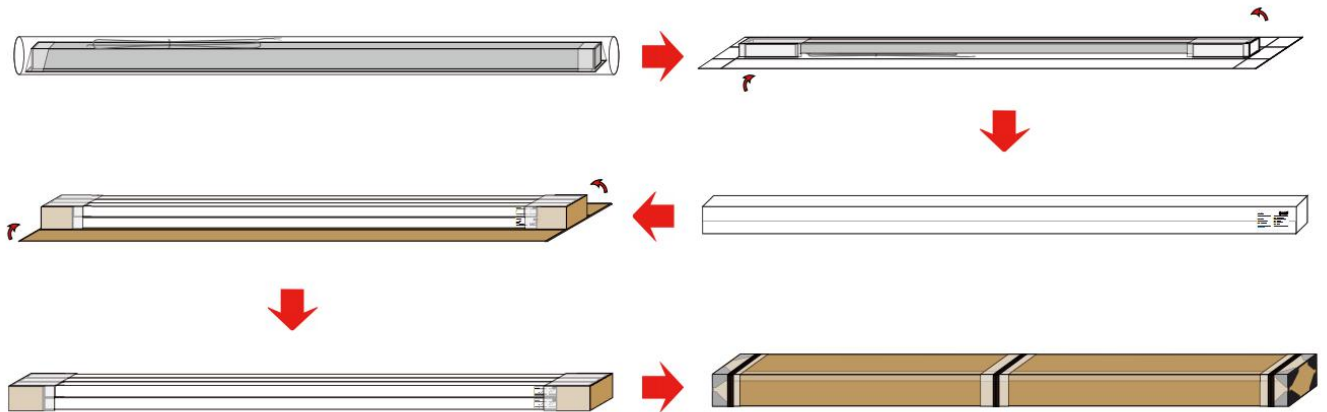

SEL Whole :

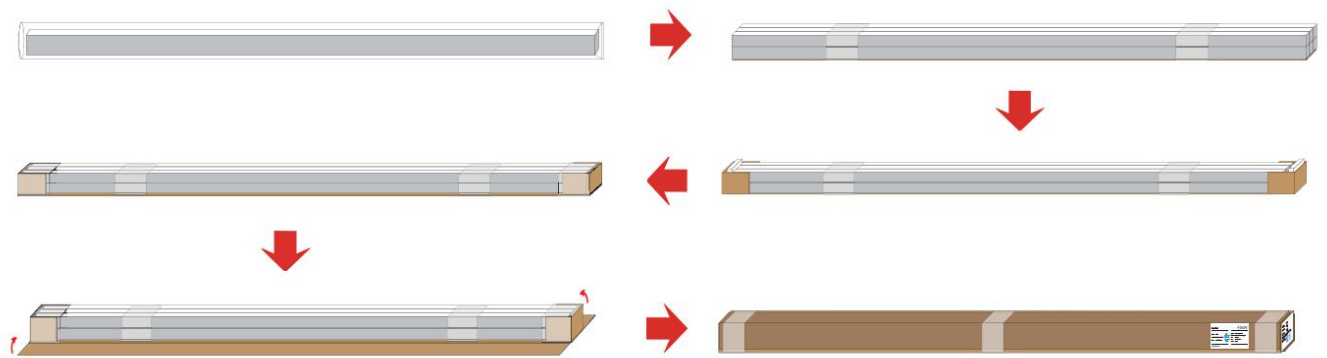

Components	Packaging material	Size(mm)	NW(kg)	GW(kg)	Content
Single piece	Hat box	2560*89*44mm	2.79	3.9	1pcs/box
SEL Individual	Hat box	2580*207*156mm	16.74	19.74	6pcs/box
SEL Whole	Paper box	2580*162*147mm	22.32	25.32	6pcs/box